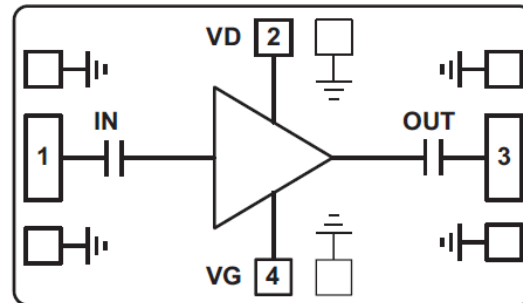

Features

- Gain: 19dB
- P1dB: +16dBm
- Noise Figure: 1.8dB
- Biasing: +3.5V @ 96 mA
- Impedance: 50Ω
- Die Size: 1.15 x 1 x 0.1 mm

Typical Applications

- Test Instrumentation
- Microwave Radio & VSAT
- Military & Space
- Telecom Infrastructure
- Fiber Optics

Functional Block Diagram

Electrical Specifications

TA = +25°C, Vdd = +3.5V Idd = 96mA

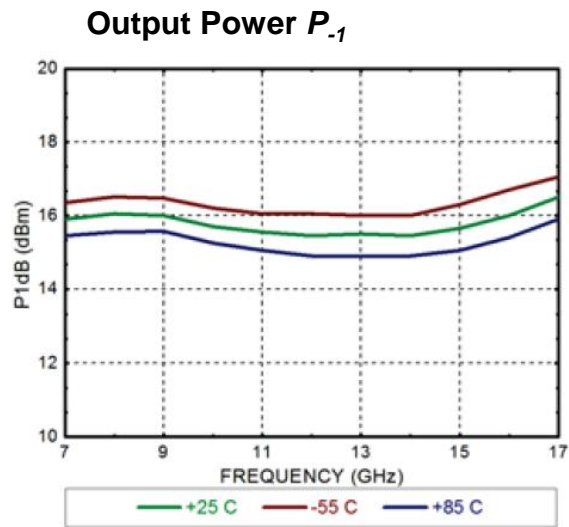
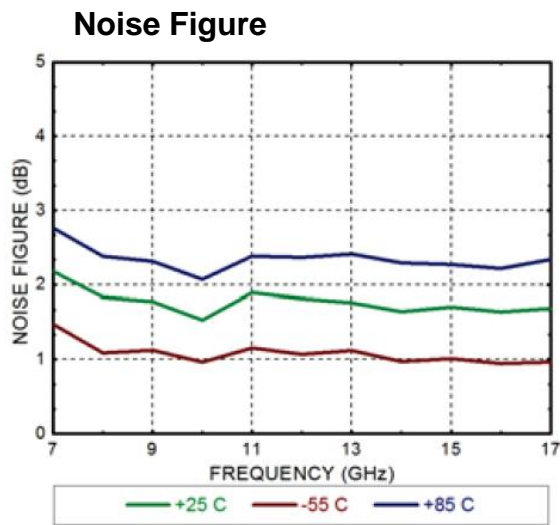
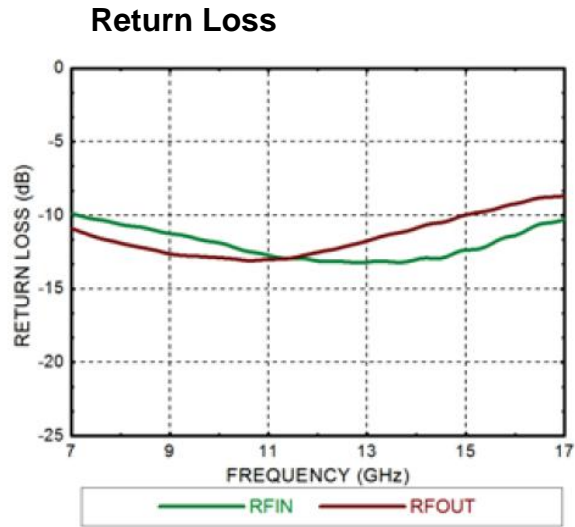
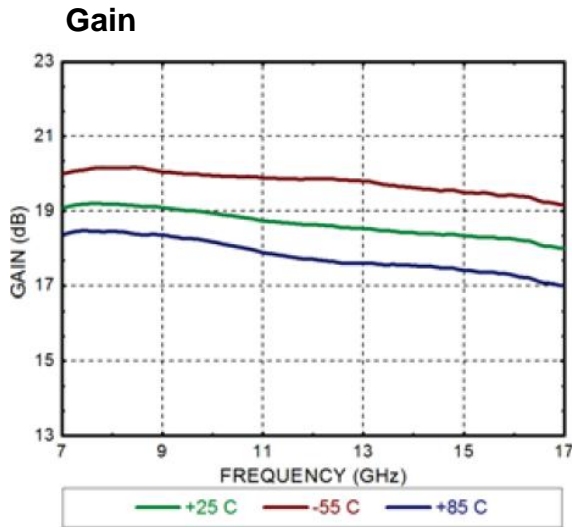
Parameters	Min.	Typ.	Max.	Units
Frequency	7 - 17			GHz
Gain		19		dB
Gain Flatness		±0.6		dB
Input Return Loss		10		dB
Output Return Loss		10		dB
Output 1dB Compression (P1dB)		16		dBm
Saturated Output Power (Psat)		19		dBm
Output Third Order Intercept (IP3)		25		dBm
Noise Figure		1.8		dB
Current	70	96	120	mA





Outline Drawing:

All Dimensions in mm

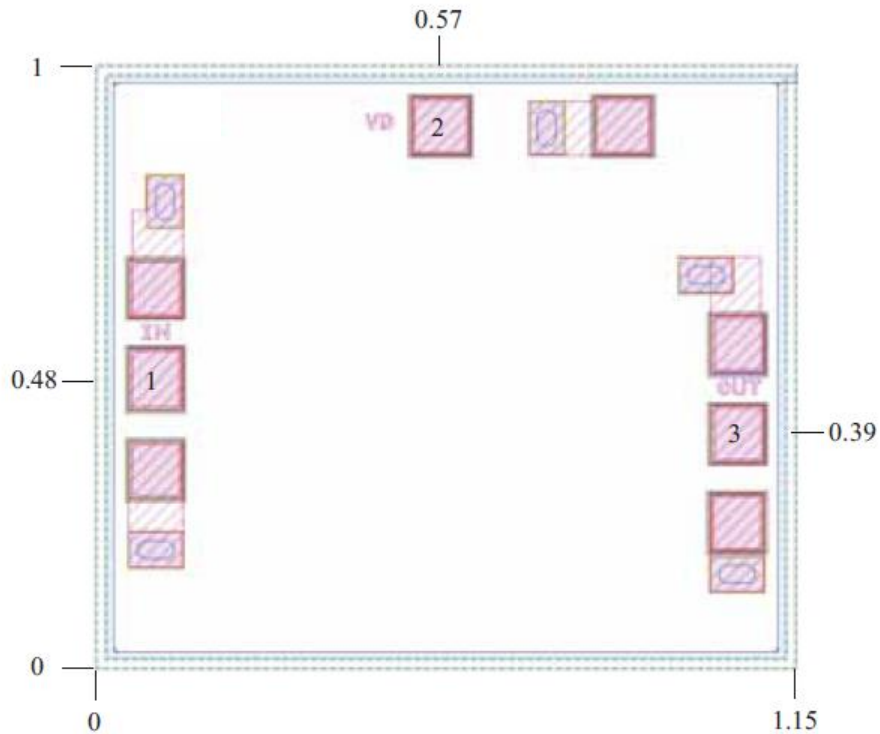

Pad Description

PAD	Function	Description
1	IN	Input AC coupling 50Ω Impedance
2	VD	The pad provides the power supply voltage of the amplifier and needs to be externally connected with the 100pF bypass capacitor.
3	OUT	Output AC coupling 50Ω Impedance
Die Bottom	GND	Die bottom must be connected to RF/DC ground



Assembly Drawing

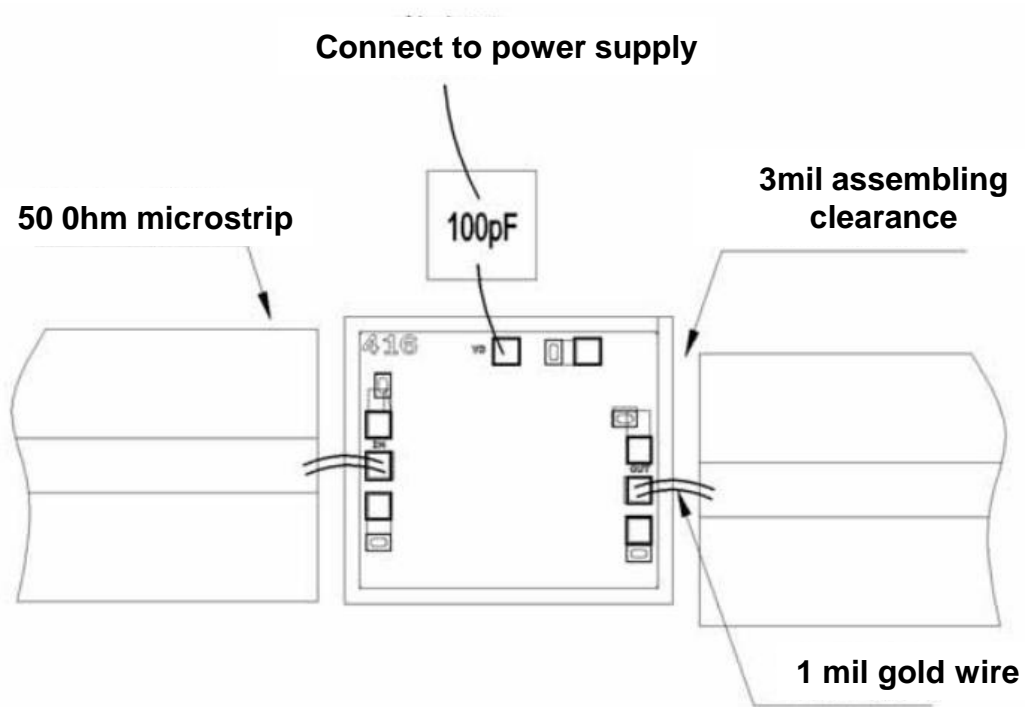

Notes:

1. Die thickness: 100um
2. Typical bond pad is 100*100 μm^2
3. Bond pad metalization: Gold
4. Backside metalization: Gold
5. Backside of the die (GND)
6. No connection required for unlabeled bond pads

Maximum Ratings:

1. Power supply voltage: +5V
2. RF input power: +18dBm
3. Storage temperature: -65°C to +175°C
4. Operating temperature: -55°C to +85°C