

Features

- Frequency: 4-18GHz
- Insertion Loss: 1.0dB Typical
- Isolation: 20dB Typical
- Input/Output: 50Ω
- Chip Size: 2.95 x 1.67 x 0.1mm

Functional Block Diagram

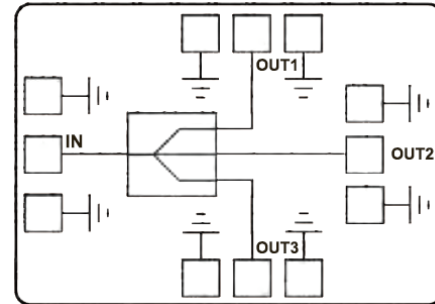

Typical Applications

- Test Instrumentation
- Microwave Radio & VSAT
- Military & Space
- Telecom Infrastructure
- Fiber Optics

Electrical Specifications

TA = +25°C ,Pin=0dBm

Parameters	Min.	Typ.	Max.	Units
Frequency	4		18	GHz
Nominal Splitter Loss		4.8		dB
Insertion Loss		1.0	1.3	dB
Insertion Loss Flatness		±0.3		dB
Amplitude Imbalance		±0.2		dB
Phase Imbalance		±3		deg
Isolation	17	20		dB
Input Return Loss		-18		dB
Output Return Loss		-14		dB



Insertion Loss vs. Frequency

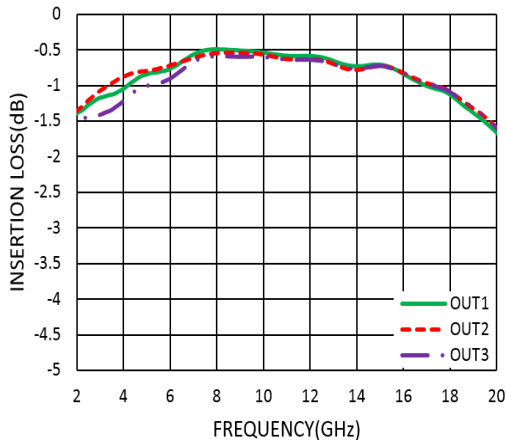

Return Loss vs. Frequency

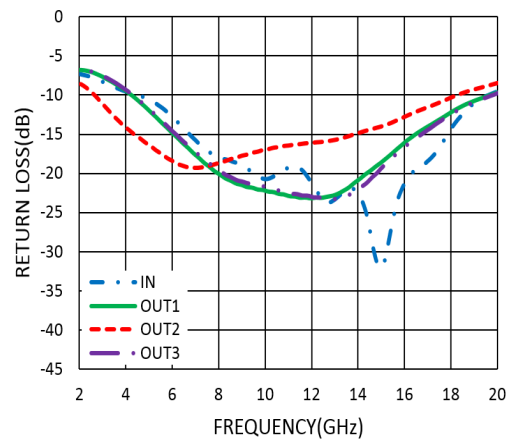

Isolation vs. Frequency

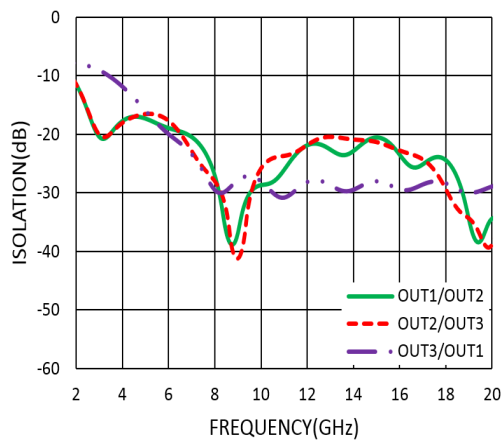

Phase Imbalance vs. Frequency

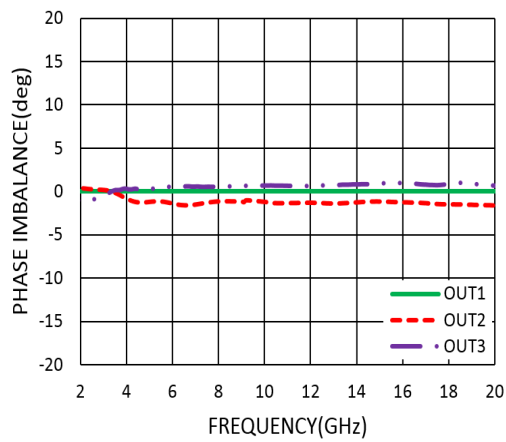

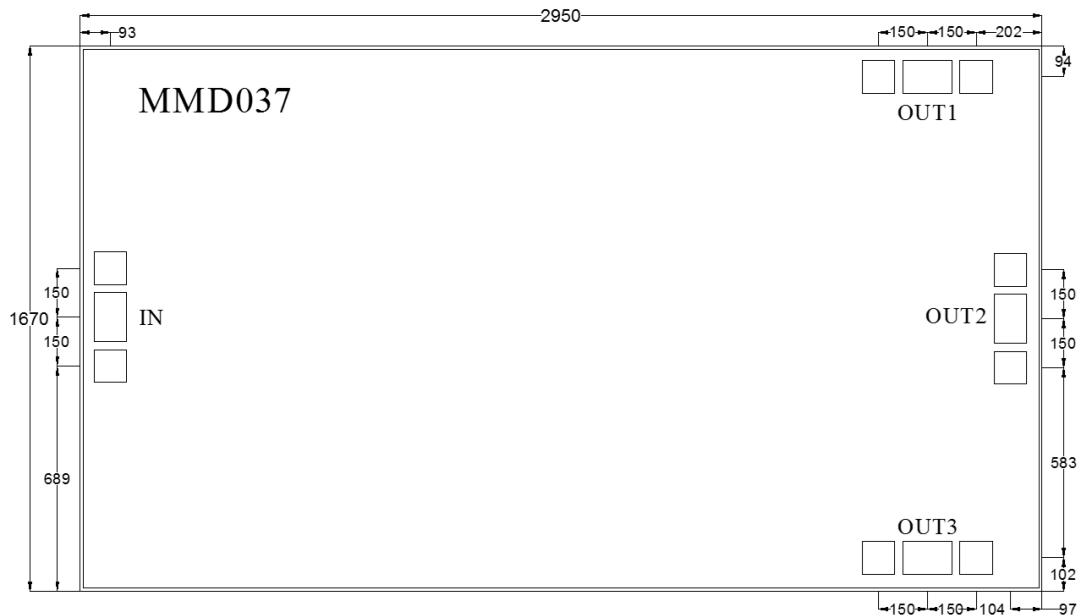
Outline Drawing: All Dimensions in μm

Absolute Maximum Ratings

RF Input Power	+30dBm
Operating Temperature	-55°C to +80°C
Storage Temperature	-65°C to +150°C

Notes:

1. Die thickness: 100 μm
2. IN/OUT2 bond pad is 100*150 μm^2
3. OUT1/OUT3 bond pad is 150*100 μm^2
4. Bond pad metalization: Gold
5. Backside metalization: Gold

No.	Function	Description
1	IN	RF Common Port
2	OUT1,OUT2,OUT3	RF Branch Ports



Mounting & Bonding Techniques for MMICs

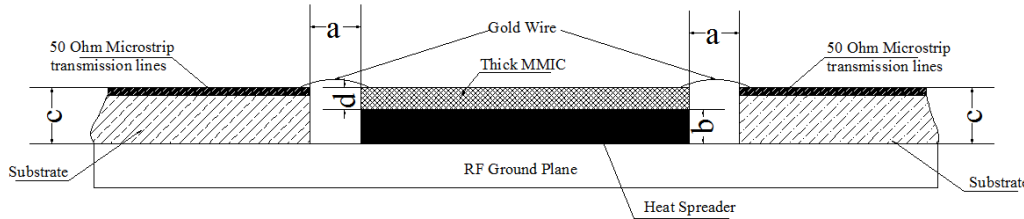

Direct Mounting

1. Typically, the die is mounted directly on the ground plane.
2. If the thickness difference between the substrate (thickness c) and the die (thickness d) exceeds 0.05 mm (i.e., $c - d > 0.05$ mm), it is recommended to first mount the die on a heat spreader, then attach the heat spreader to the ground plane.
3. Heat Spreader Material: Molybdenum-copper (MoCu) alloy is commonly used.
4. Heat Sink Thickness (b): Should be within the range of $(c - d - 0.05$ mm) to $(c - d + 0.05$ mm).
5. Spacing (a): The gap between the bare die and the 50Ω transmission line should typically be 0.05 mm to 0.1 mm. If the application frequency is higher than 40GHz, then this gap is recommended to be 0.05mm

Wire Bonding Interconnection

The connection between the die and the 50Ω transmission line is usually made using 25 μm diameter gold (Au) wires, bonded via wedge bonding or ball bonding processes.

Die Attachment Methods

1. Conductive Epoxy:

After adhesive application, cure according to the manufacturer's recommended temperature profile.

2. Au-Sn80/20 Eutectic Bonding:

Use preformed Au-Sn80/20 solder preforms.

Perform bonding in an inert atmosphere (N_2 or forming gas: 90% N_2 + 10% H_2).

Keep the time above 320°C to less than 20 seconds to prevent excessive intermetallic formation.

Miller MMIC Inc. All rights reserved

Miller MMIC, Inc. holds exclusive rights to the information presented in its Data Sheet and any accompanying materials. As a premier supplier of cutting-edge RF solutions, Miller MMIC has made this information easily accessible to its clients.

Although Miller MMIC believes the information provided in its Data Sheet to be trustworthy, the company does not offer any guarantees as to its accuracy. Therefore, Miller MMIC bears no responsibility for the use of this information. It is worth mentioning that the information within the Data Sheet may be altered without prior notification.

Customers are encouraged to obtain and verify the most recent and pertinent information before placing any orders for Miller MMIC products. The information in the Data Sheet does not confer, either explicitly or implicitly, any rights or licenses with regards to patents or other forms of intellectual property to any third party.

The information provided in the Data Sheet, or its utilization, does not bestow any patent rights, licenses, or other forms of intellectual property rights to any individual or entity, whether in regards to the information itself or anything described by such information. Furthermore, Miller MMIC products are not intended for use as critical components in applications where failure could result in severe injury or death, such as medical or life-saving equipment, or life-sustaining applications, or in any situation where failure could cause serious personal injury or death.