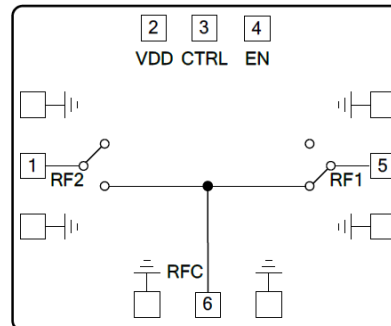

Features

- Positive voltage control
- Isolation: 36dB@ 40GHz
- Insertion Loss: 1.2dB@ 20GHz
- 2.0dB@ 40GHz
- SPDT Reflective design
- Power supply: +5V@ 2mA
- Die Size: 1.14x0.97x 0.1 mm

Typical Applications

- TTL compatible driver included
- Fast Switching Speed
- Low Insertion Loss and High Isolation
- Customization available upon request

Functional Block Diagram

Electrical Specifications
TA = +25°C, CTRL=0/+3.3V, VDD= +5V

Parameters	Min.	Typ.	Max.	Units
Frequency	0.1-40			GHz
Insertion Loss		1.5		dB
Isolation		45		dB
Return Loss (OFF State)		20		dB
Input 1dB Compression@1-40GHz		24		dBm
Switching Speed		25		ns

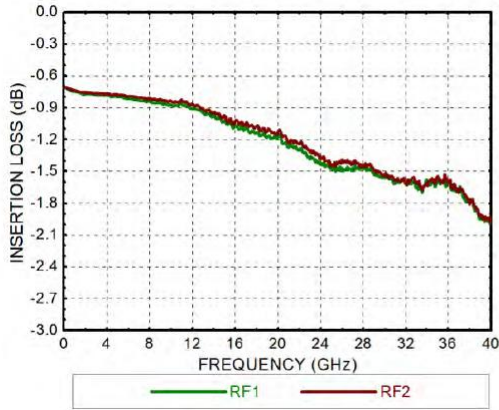

Insertion Loss



Isolation

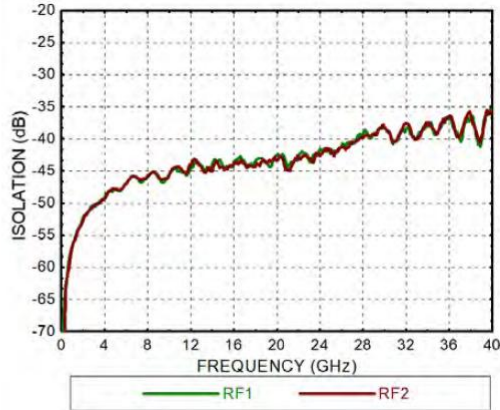

Return Loss (ON State)

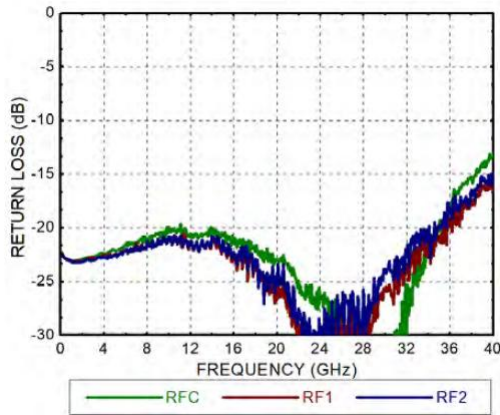

Return Loss (OFF State)

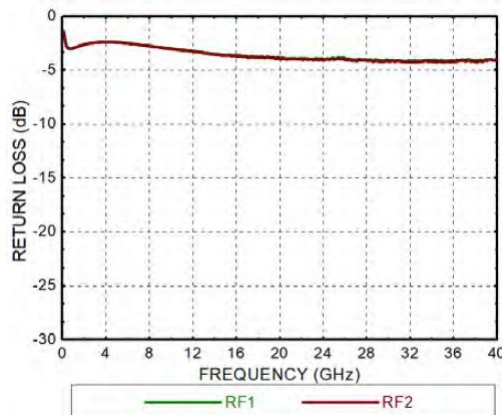



Outline Drawing:

All Dimensions in mm

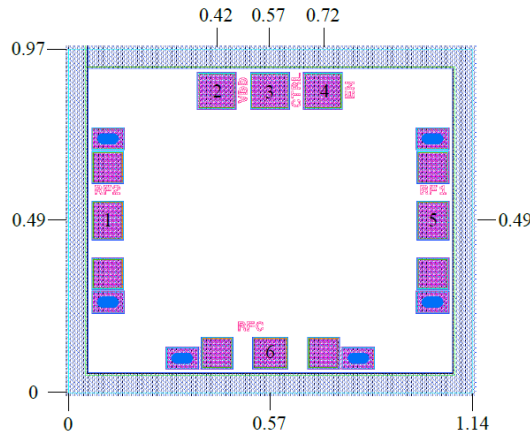

Pad Description

PAD	Function	Description
1,5	RF2,RF1	RF branch port, blocking capacitor is required externally.
6	RFC	RF common port, blocking capacitor is required externally.
3,4	CTRL, EN	When EN=0V, CTRL=0V, then RF1 is "ON" state, RF2 is "OFF" state; When EN=0V, CTRL=+3.3V, then RF1 is "OFF" state, RF2 is "ON" state; When EN=+3.3V, then RF1 is "OFF" state, RF2 is "OFF" state.
2	VDD	Digital circuit power supply port, connected to +5V voltage.
Die Bottom	GND	Die bottom must be connected to RF/DC ground.

True Table

Function	EN	CTRL
RFC-RF1	0	0
RFC-RF2	0	1
ALL OFF	1	-
"0" voltage range:0~0.8V, "1" voltage range:2.3~5V		



Assembly Drawing

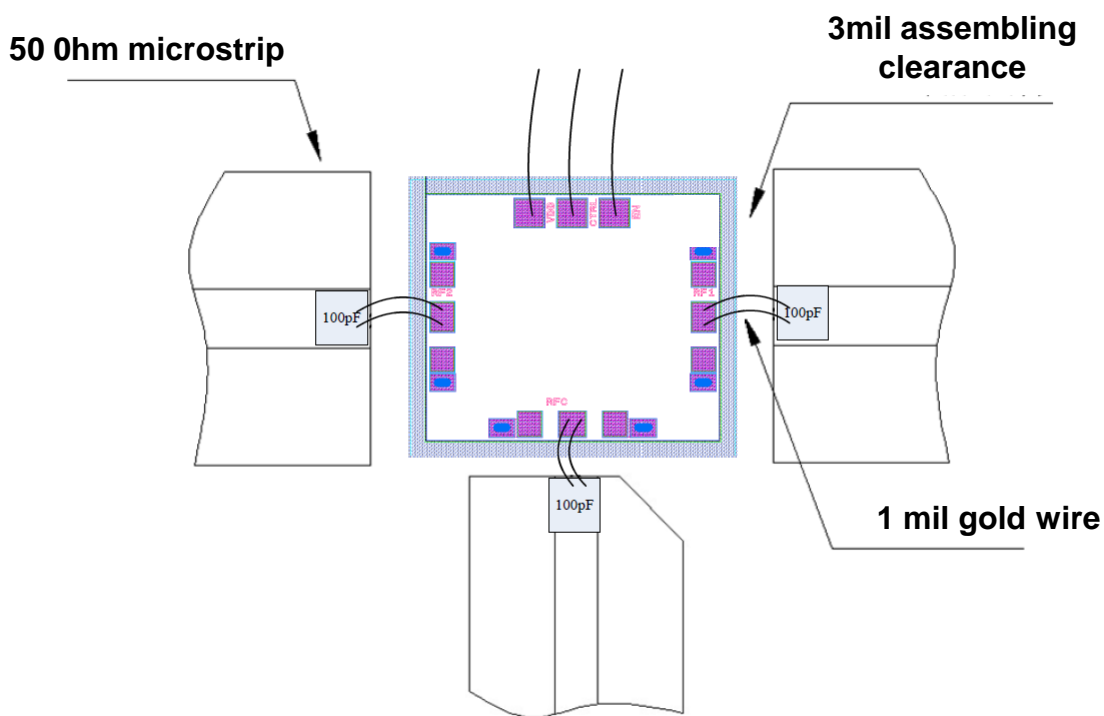

Notes:

1. Die thickness: 100um
2. Typical bond pad is $100 \times 80 \mu\text{m}^2$
3. Bond pad metalization: Gold
4. Backside metalization: Gold
5. Backside of the die (GND)
6. No connection required for unlabeled bond pads

Maximum Ratings:

1. Power supply: +6V
2. RF input power: +27dBm
3. Storage temperature: -65°C to +150°C
4. Operating temperature: -55°C to +85°C